

Article number: 20133B25B162SW

Description: E+G Two-way Connector  
GN133-B25-B16-2-SW

## Measures

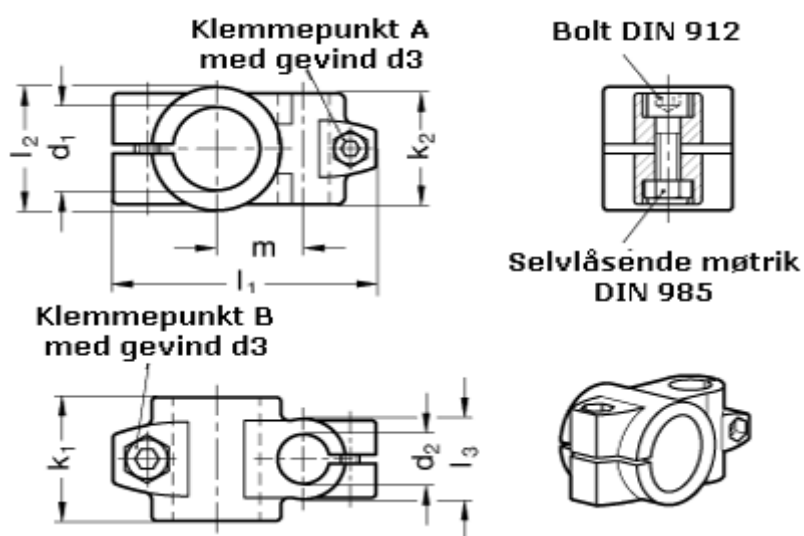

Adjustable clamp lever for d3 = GN 911-M 8-32 have to be ordred separately

Adjustable clamp lever for d4 = GN 911-M 6-25 have to be ordred separately

d1 = 25

d2 = 16

d3 = M 8

d4 = M 6

k1 = 40

k2 = 36

l1 = 81.5

l2 = 40

l3 = 26

m = 27